

OPERATING AND INSTALLATION INSTRUCTIONS

SCAN-LINE 500 SERIES

Scan-line 500 serie SCA is exempt for use in smoke control areas when burning dry wood



www.heta.dk

ECODESIGN READY



EN

DANISH DESIGN . DANISH QUALITY . DANISH PRODUCTION



Declaration of Performance EN

Regulation No. 305/2011
DOP-Scan-Line 500 serien-2354-2018-EN

| | |
|--|--|
| 1. Unique identification code of product-type | Stove |
| 2. Product name | Scan-Line 500, 510, 520, 520B, 550, 551, 560S, 560B, 590, Turin Classic, Turin Modern, Napoli, Scan-Line 40-50 |
| 3. Intended use or uses of the construction product, in accordance with the applicable technical specification | Room heater burning solid fuel without hot water supply |
| 4. Name and contact address of the manufacturer | Heta A/S, Jupitervej 22, DK-7620 Lemvig. heta@heta.dk |
| 5. Where applicable, name and contact address of authorized representative. E-mail. | Martin Bach, E-mail: martin.bach@heta.dk |
| 6. System of assessment and verification of constancy of performance of the construction product | System 3 |
| 7. Notified body relevant to the assessment and verification of constancy of performance | Teknologisk Institut, DK-8000 Aarhus Notified body No. 1235 Rapport nr. 300-ELAB-2354-EN |

8. Declared Performance

| | |
|------------------------------------|--|
| Harmonized technical specification | EN 13240:2001/A2:2004 |
| Emission | CO 0,0394% / 493 mg/Nm ³ Nox 90 mg/Nm ³ Dust 22 mg/Nm ³ Dust (NS3058/3059) OGC (CEN/TS 15883) 51 mgC/Nm ³ - 13% O ₂ |

Fire safety

| | |
|--|-------------------------|
| Reaction to fire | A1 |
| Test of fire safety in connection with the burning of wood | Approved |
| Distance to combustible materials | Minimum distances in mm |
| Rear | 150 |
| Sides distance to combustible materials | 350 |
| Furniture distance | 1000 |

Safety

| | |
|---|------------------|
| Mechanical resistance (to carry a chimney / flue) | Not tested (NPD) |
| Electrical safety | NA |
| Surface temperature | Approved |
| Cleanability | No specification |

Thermal output

| | |
|--|------------|
| Nominal heat output | 6,1 kW |
| Room heat output | 6,1 kW |
| Energy efficiency | η 83% |
| Fluegas temperature at nominal heat output | T 246°C |
| Water heating output | NA |
| Maximum water operating pressure | NA |

9.

The performance of the product identified in points 1 and 2 is in conformity with the declared performance in point 8. This declaration of performance is issued under the sole responsibility of the manufacturer.

Signed on behalf the manufacturer of 04.12.2018

Heta A/s
JUPITERVEJ 22 · DK-7620 LEMVIG
Tlf. +45 9663 0600 · Fax +45 9663 0616
Martin Bach

In case of any change of the above-mentioned production type this Declaration of Performance becomes invalid.
Heta A/S, Jupitervej 22, DK-7620 Lemvig, Tlf. +45 9663 0600, www.heta.dk

Congratulations on your new wood stove, we are confident that you will be more than satisfied with your new Heta stove. Especially if you follow the following advice and instructions.

Scan-Line 500 series have been approved according to the EN 13240: 2005 / A2: 2004 / NS 3058, and the Scan-Line 500 SCA series are modified so that they are also recommended as exempt for use within smoke control areas (SCA) throughout the UK (see clean air act Appendix A). of the air supply regulation so that it can't be closed completely.

Operating Instructions

Contents

| | |
|---|-----|
| Declaration of Performance | 2 |
| Before installation..... | 4-5 |
| 1. Before installation..... | 6 |
| 1.1 Before using | 6 |
| 1.2 First firing | 6 |
| 1.3 Regulating the airflow..... | 6 |
| 1.4 Lighting the stove..... | 6 |
| 1.5 Refueling | 6 |
| 1.6 Emptying the ash | 7 |
| 1.7 Reduced burning..... | 7 |
| 1.8 Risk of explosion..... | 7 |
| 1.9 Draft conditions in the chimney | 7 |
| 1.10 Fuel..... | 8 |
| 1.11 Operating problems | 9 |
| 1.12 Chimney fire | 9 |
| 1.13 Troubleshooting table | 10 |
| 1.14 Diagram for maintenance..... | 11 |
| 1.15 Maintenance C..... | 11 |
| 1.16 leaning the glass | 11 |
| 1.17 Cleaning/Replacing bicks | 12 |
| 1.18 Stove data table EN 13240 | 13 |
| 1.19 Garantie..... | 13 |
| 1.20 Parts..... | 14 |
| 2. Installation Instructions | 15 |

Heta A/S

Jupitervej 22,
DK-7620 Lemvig

Phone: +45 9663 0600
E-mail: heta@heta.dk

Copyright © 2014
Heta is a registered
trademark of Heta A/S

Printed in Denmark
Subject to printing errors
and changes.

02.01.2020
0037-1205 Version 1,2

BEFORE INSTALLATION

Heta wood stoves are quality products, therefore, your first impression is very important! We have a good logistics network, which transports Heta products with great care for our dealers. Nevertheless, when in transport or handling, damage of the often-heavy stoves can occur. It is important that upon receipt check your Heta product completely and report any damage or defects to your dealer.

The packaging must be disposed of as follows:



Wood is untreated and able to burn in the stove.

Plastic and cardboard you can drop off at your local recycling center.

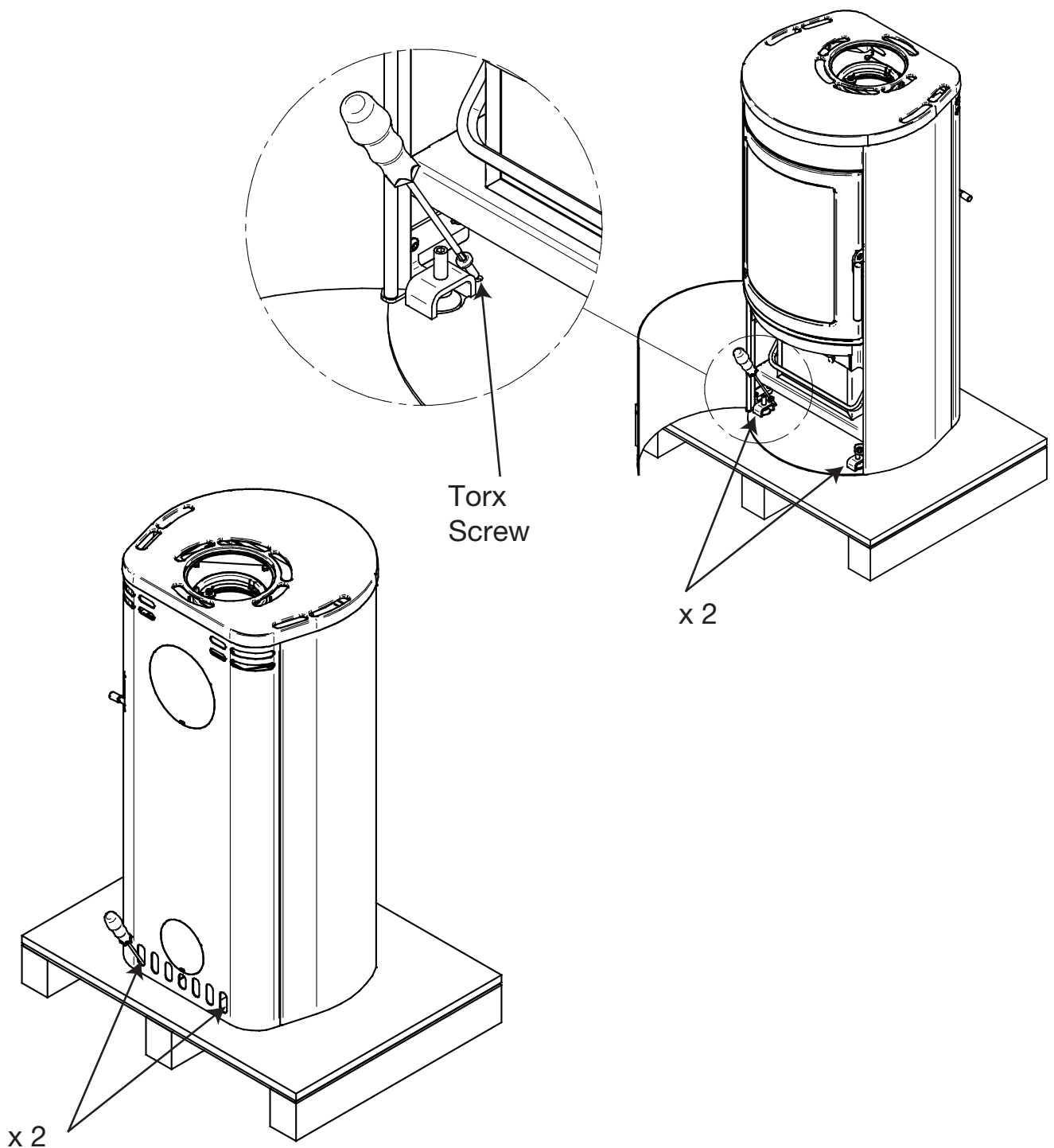
Unpacking the stove

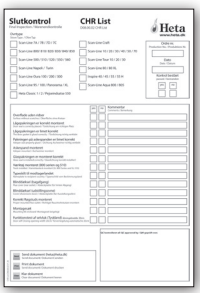

With your new wood stove you should find the following:

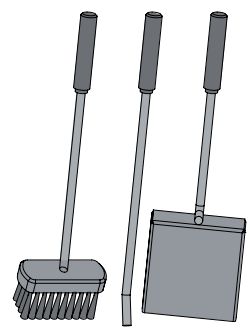
| | | | |
|---|--|--|---|
| <p>Operating / Instruction manual</p> |  | <p>Q.C. check</p> |  |
| <p>Heta glove</p> |  | <p>Data plate</p> |  |
| <p>Tool set Scan-Line 510</p> |  | <p>Required tools and grease are not supplied.</p> | |

1. OPERATING INSTRUCTIONS

1.1 Before using

Before the wood stove is used make sure required installation conditions, are met.

See page 16.

1.2 First firing

The stove paint is fully cured from the factory, but a minor unpleasant odour could still arise.

1.3 Regulating the air flow

To open the flow of combustion air, use the operating handle at the back of the side panel. The combustion airflow is completely open in top position, fig. 1. Shut off the combustion airflow gradually by lowering the handle. The supply is completely shut off when the handle is at its bottom position, fig. 2.

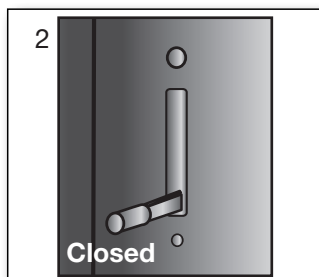
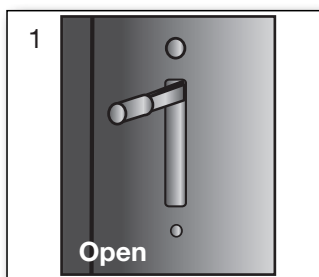

1.4 Lighting the stove

Place two pieces of wood on the bottom. Stack kindling on top in layers with air between. Set fire starter (bag, brick, paraffin) on the top, now you are ready to light the fuel. The flames must work from the top down.



The use of lighter fluid, oils or any liquid fuels is strictly forbidden from use in a wood stove.

Fully open the combustion air into the start-up air position and the door ajar (about one cm open). Once the fire is established and the chimney is hot (after about ten minutes) closed door and regulate the air into operating position. We recommend, all of the first fuel is burned with the combustion air fully open in the operating position. This ensures the stove and chimney are thoroughly heated.

If the fire dies down completely or embers are

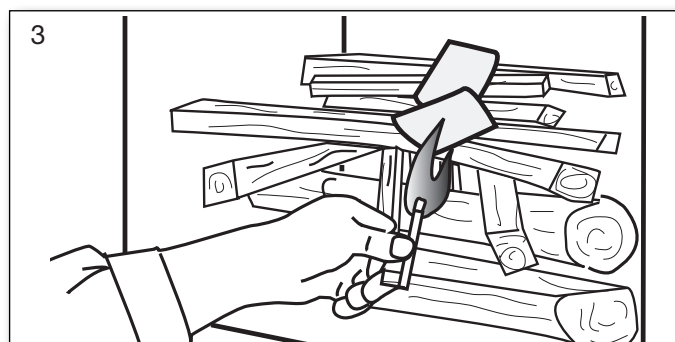

smoldering, then it will be necessary to place some firelighters onto the grate with some kindling or small pieces of wood to the fire once again. Leave the air control fully open and allow the fire to build before refueling with larger pieces of wood. Then adjust the air control for optimum combustion. Do not overload the firebox by loading above the tertiary air diffuser at the back of the firebox and ensure that the wood is retained by the log guard. Always ensure that the wood is not tightly stacked so that air can circulate freely.

Do not leave the door open:

Operation with the door open can cause excess smoke. The appliance must not be operated with the appliance door left open except as directed in the instructions.

Do not leave the air control completely open:

Operation with the air control permanently open can cause excess smoke. The appliance must not be operated with air controls or dampers left open except as directed in the instructions.



Startup/Lighting

Scan the code and select a language.

1.5 Refueling

Refueling of your stove should be done while there is still a good layer of embers. Distribute the embers with the majority of them to the front. Place pieces of wood equivalent to about 1,2 kg on top of the embers perpendicular to the door. Now open the combustion air completely. If the stove and/or chimney cools down too much, it may be necessary to have the door ajar.

The wood will then ignite within a very short time (Typically 1 to 3 minutes). Once the fuel is ignited. Close the door and regulate the air back to operating air. When the fire is well established, you

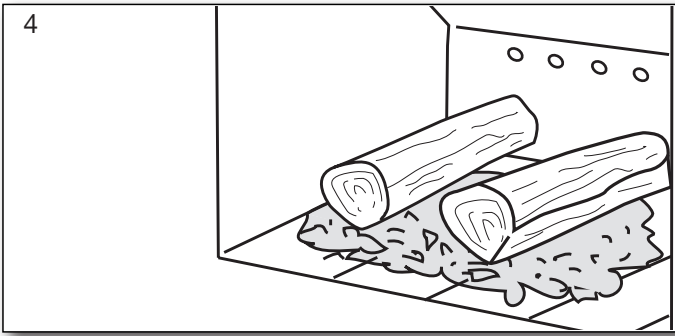

can now regulate the operating air to the desired combustion level.

Rated output measured when the combustion air is about 38% open.

Ensure when refueling that the wood is not too close, it will cause poorer combustion, less heat out-put and lower efficiency.

The fuel load, must be maintained below the top series of air holes and within the outer vent in each side. Fig. 5

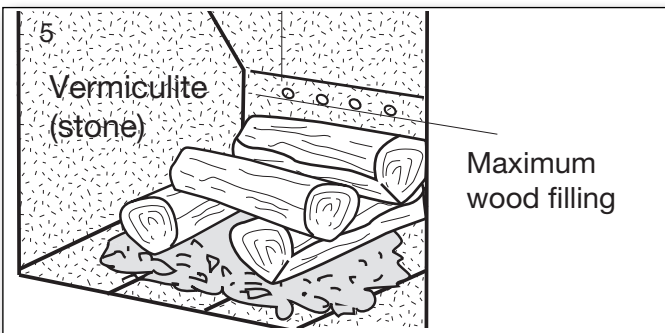

When refueling be careful to place the fuel into the combustion chamber gently, (use the provided glove). By not doing so you risk cracking or breaking the vermiculite.

If there is reduced draft in the chimney, we recommend opening a window at stoking. This will give better ventilation to the room and more

1.6 Emptying the ash

By using the shaker grate, it rotates back and forth so the ash falls through the holes and into the ashtray. It is advantageous to leave a layer of ash in the bottom of the combustion chamber on top of the grate as insulation.



Be careful when emptying the ashes out. There can be hot embers left for a long time.

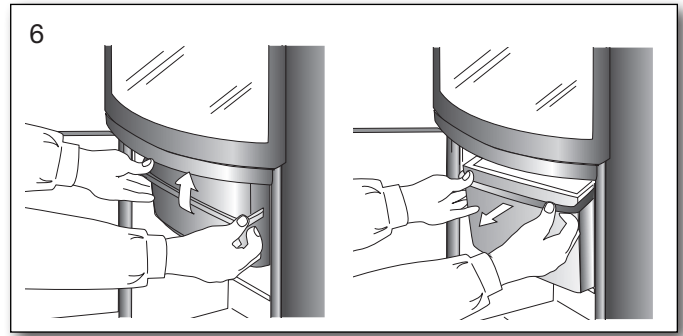

Lubricate Ash pan

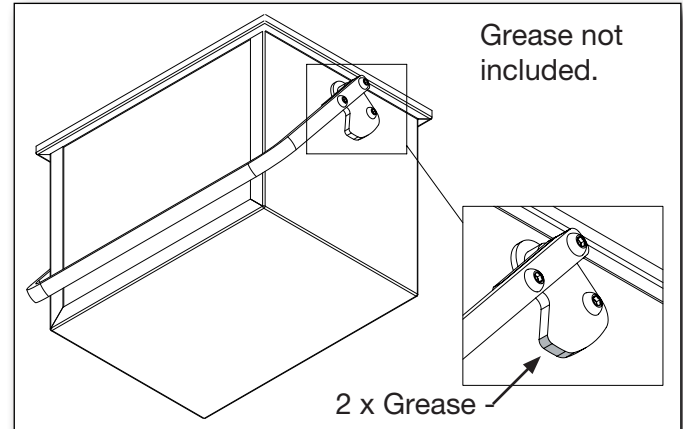

1.7 Reduced burning

The stove is, designed for intermittent use. It is important to maintain the layer of hot embers. Lower heat out-put occurs when no flames are coming from the wood and it is becoming hot embers.

If you are looking for less heat out-put, achieve this by fueling with smaller volumes of wood and a lower operating air. You may not completely close the operating air during firing.

Be aware that the stove will naturally soot if the operating air is too low. This is not good for the environment. There is also a risk for the glass, the chimney and other parts will become sooted.

By a combination of the above and possibly burning damp wood. Can lead to high levels of soot that it becomes sticky. Causing the sealing of the door to tear off when opening the door the next day.

1.8 Explosion!!!



It is very important never to leave The stove after start up or refueling, before the fire is established. (Typically 1 to 3 minutes)

Explosion can occur if filled with too much fuel in the stove, the production of large volumes of gas, which can explode if the air supply becomes too low.

Warning!



One must always use caution around the stove seen, as it gets very warm during use. (In excess of 90° C).

Children should avoid contact with the stove.

Setting up a fence if you have small children may be necessary.

Do not place flammable objects like drying racks, furniture, curtains too close to the stove.

1.9 Draft conditions and the chimney

Poor draft will not allow the stove to burn, as it should. The glass can soot, requires cleaning of the chimney more often, smoke can escape out when the door is open and it gives poor fuel efficiency. Leading to unnecessary polluting of the environment.

Good draft will allow the stove to achieve optimal combustion and the highest possible efficiency. Heta wood stoves are constructed so that it itself provides an optimal blend of combustion air. This provides a high efficiency/heat, clean glass and low environmental impact.

Minimum chimney draft: 11 pascal.

It is the draft that the stove has been tested and approved on. The minimum draft is necessary to provide clean burning, beautiful flame picture, as well as achieving the rated efficiency.

There is a risk of smoke escaping into the room if the door is opened during vigorous firing, or if there is a lack of air supply to the room, for ex. if an extraction fan is in use.

246°C, relative to 20°C.

Flue gas flow is: 4,7 g/sec.

The chimney height and diameter, as well as the temperature difference between the flue gas and outside temperature generates the chimney draft. Chimney insulation is therefore important as new efficient stoves create lower flue temperatures. Wind and weather conditions also influence draft, in some cases it may be disadvantageous wind direction, combined with the position of the chimney can cause negative draft (it blows through the chimney), causing smoke escape from the stove.

Before using after a long period of inactivity,

check that the chimney is free for any blockages. (soot build-up, bird nests, leaves etc.).

Reduced draft can occur when:

- The temperature difference is too small between smoke gasses and outdoor temperature, for eg. poorly insulated chimney
- To short of a chimney
- The outside temperature is high, and indoor temperature is low for eg. in summer
- False air in the chimney
- Chimney is blocked
- Air tight house (lack of combustion air supply)
- Poorly placed chimney for the surroundings, for ex. the ridge and trees may cause turbulence

Good draft occurs when:

- The difference in temperature in the chimney (warmer) and outside temperature (colder)
- It is clear weather
- The chimney has the right height min 4 meters above the stove, and clear of the roof ridge

1.10 Fuel

Your new stove is EN approved for firing with wood fuel. You must therefore only burn clean, dry wood in your stove. Never use your stove to burn driftwood, as this may contain a lot of salt which can damage both the stove and the chimney. Similarly, you must not fire your stove with refuse, painted wood, pressure-impregnated wood or chipboard, as these materials can emit poisonous fumes and smoke.

Correct firing using well seasoned wood provides optimal heat output and maximum efficiency. At the same time, correct firing prevents environmental damage in the form of smoke emissions and reduces the risk of chimney fires.

If the wood is damp and inadequately seasoned, a large proportion of the energy in the fuel will be used to vaporize the water and this will all disappear up the chimney. Thus, it is important to use dry, well seasoned wood, for eg. wood with a moisture content of less than 20 %. Achieve this by storing the wood for 1–2 years before use.

Pieces of firewood with a diameter of more than 10 cm should be split before before storing. The pieces of firewood should be of an appropriate length (approx. 19-25 cm) so that they can lie flat on the bed of embers.

If you store your wood outdoors, it is best to cover it.

Examples of fuel values

for different woods and their typical densities per cubic meter, specified for 100% wood with a moisture content of 18%.

| Wood | kg/m ³ | Willow | kg/m ³ |
|---------------|-------------------|-------------|-------------------|
| Beech | 710 | Wood | 560 |
| Oak | 700 | Alder | 540 |
| Ash | 700 | Scotch pine | 520 |
| Elm | 690 | Larch | 520 |
| Maple | 660 | Lime | 510 |
| Birch | 620 | Spruce | 450 |
| Mountain pine | 600 | Poplar | 450 |

It is advised not to use oil-containing woods like teak tree and mahogany, as this can cause damage to the glass.

Heating value in wood

You have to use about 2.4 kg normal wood to replace one litre of heating oil. All woods have almost the same heating value per kg, which is about 5.27 kW/hour for absolute dry wood.

Wood with a moistness of 18% has a efficiency of about 4.18 kW / hour per kg, and one litre heating oil contains about 10 kW / hour.

CO₂ release

At combustion 1000 litres of heating oil forms 3.171 tons CO₂. As wood is a CO₂ neutral heat/energy source, you save the environment about 1.3 kg CO₂ every time you have used 1 kg normal wood.

1.11 Operational problems

The chimney must be swept at least once a year, we recommend the use of a NACS (national association of chimney sweeps) registered chimney sweep.

In the event of smoke or malodorous fumes are being produced, you must first check to see whether the chimney is blocked.

The chimney must, of course, always provide the minimum draft necessary to ensure that it is possible to regulate the fire. Please note, however, that chimney draft is dependent on the weather conditions. In high winds, the draft can become so powerful that it may be necessary to fit a damper in the flue gas pipe to regulate the draft.

When cleaning the chimney, soot and other deposits may come to fall on the baffle plate, remove and clean it. In cases where the wood burns too quickly, this may be due to excessive chimney draft. You should also check to make sure that the door seal and ash pan seal is intact and correctly fitting.

If the stove is generating too little heat, this may be because you are firing with wet wood. In this case, much of the heating energy is used to dry the wood, resulting in poor efficiency, potentially damaging the vermiculite and an increased risk of soot deposits in the chimney.

1.12 Chimney fire

In case of a chimney fire, which often results from incorrect operation/maintenance or prolonged use of damp wood, close the door and the air supply completely, to help slow/smother the fire.

Call the fire department. The stove and chimney must be inspected before use again.

1.13 Troubleshooting table - applies to all stove types

| Fault | Cause | Troubleshooting | Solution |
|--|---|---|---|
| Lighting problems. When the stove is cold, smoke seeps into the room. Once the combustion chamber has heated up, the stove burns well. | Inadequate chimney draft. The chimney only has sufficient draft when it is hot. | You can test using a lighter whether flame is drawn into the combustion chamber. | Improve the chimney. |
| The stove burns poorly after the warm-up phase, and the glass slowly soots up. | Soot in the flue pipe. | Check the flue pipe regularly, as the problem arises slowly. | Clean regularly, and limit the use of horizontal flue pipes. Do not use firewood which generates large quantities of ash. |
| If the stove burns poorly after start-up, and the glass slowly soots up. | Inadequate chimney draft. | The fault usually already occurs during lighting. Measure the chimney draft. | Improve the chimney draft. |
| | Insufficient air supply. | Check the air supply. | Read the operating instructions and instruct all users. |
| | Damp wood. | Use clean, dry wood with a maximum moisture content of 20%. | Firewood should ideally be dried for at least one year after splitting. |
| | Firewood pieces too large. | Optimal size – see the section for firewood, max. diameter 10 cm. | Use smaller pieces of firewood. |
| | Insufficient air supply to the room. Range hoods, airtight windows, etc. | Ensure there is sufficient fresh air supply, open a window, check the outdoor air supply. | Depending on the cause, windows must be opened or the outdoor air connection cleaned. |
| | Insufficient air supply to the room. Range hoods, airtight windows, etc | Ensure there is sufficient fresh air supply, open a window, check the outdoor air supply. | Depending on the cause, windows must be opened or the outdoor air connection cleaned. |
| The vermiculite in the combustion chamber is becoming very worn. | Wood and flue gases wear down the vermiculite. | Investigate whether the wear is normal. | Normal wear and minor cracks are of no significance. It should be replaced when the steel of the combustion chamber is visible. |
| Too rapid combustion. | Too much chimney draft. | To test, you can open the cleaning hatch, but remember to close it again. | Measure the chimney draft and install a damper in the flue pipe if necessary. |
| | The door or ash pan/drawer seal is defective. | While cold, close a piece of paper in the door – the seal should hold the paper gently in place so it does not fall out by itself. Normal wear. | Replace the seal. |
| The vermiculite in the combustion chamber is cracked. | Shocks or impacts while adding firewood. | Normal wear | Cracks only have cosmetic significance. Replace when the steel of the combustion chamber is visible. |
| Steel surfaces in the combustion chamber have oxidised. | The temperature in the combustion chamber is too high. | Unsuitable fuel is being used (such as coal). Check the quantity of firewood being used, read the operating instructions. | If there are clear cracks or weaknesses in the stove body, it must be replaced. |
| The stove whistles | Too much chimney draft | To test, you can open the cleaning hatch, but remember to close it again. | Install a damper. |
| The stove 'clunks' | Usually due to tension in the metal plates. | Generally only occurs while heating up and cooling down. | Adjust the metal plates. |
| The stove ticks | Normal expansion and contraction due to temperature changes. | A normal sound. | Ensure that the temperature in the combustion chamber is as constant as possible. |
| The stove creaks. | The temperature in the combustion chamber is too high. | Use less firewood. Also check the seal in the ash pan/drawer. | See the operating instructions. |
| The stove smells. The surface is steaming. | The paint on the stove surface is not yet fully hardened. | See the operating instructions regarding the first firing. | Ensure there is sufficient ventilation. |
| Condensation in the combustion chamber. | Moisture in the vermiculite. | Check the condition of the vermiculite. | Evaporates by itself after the stove has been lit a few times. |
| | Damp wood. | Measure the moisture content. | Use dry firewood. |
| Condensation from the flue pipe. | The pipe is too long or the chimney is too cold. | Check the flue pipe's length and heat loss. | Improve the flue pipe, insulate the chimney. |
| | Damp wood | Measure the moisture content. | Use dry firewood. |

1.14 Diagram for the maintenance

| Maintenance / Period | Stove Owner | | | | | Qualified Technicia | |
|--|--------------|-------|--------|---------|------------|---------------------|----------|
| | Before Autum | Daily | 1 week | 30 days | 60-90 days | 1st Year | 2st Year |
| Cleaning the chimney (see. Chimney) | C | | | | | | |
| Cleaning the chimney and stove | C | | | | C | | |
| Cleaning the stoves firebox | C | VI | | | C | | |
| Cleaning combustion air intake | C | | | | C | | |
| Cleaning ash bucket | C | | VI | C | | | |
| Cleaning of the firebox | C | | VI | C | | | |
| | | | | | | | |
| Checking / switch, gasket for door | C/S | VI | | | | | C/S |
| Checking / changing, gasket for glass | C/S | VI | | | | | C/S |
| Checking / switch, gasket for ashpan | C/S | VI | | | | | C/S |
| Checking / changing gasket for flue pipe | C/S | VI | | | | | C/S |
| Checking / changing vermiculite | C/S | VI | | | | | C/S |
| | | | | | | | |
| Lubricate hinges | L | VI | | | L | | |
| Lubricate lock | L | VI | | | L | | |
| Lubricate Ash pan | L | | | | L | | |

For the lubricant used a heat-resistant product. (300c)

C = Cleaning

C/S = Checking /Switch

L = Lubricate

VI = Visual Inspection, pos. cleaning/replacing/adjusting

1.15 Maintenance

The surface of the stove is treated with a heat-resistant paint. The stove should be cleaned with a damp cloth.

Any damage to the surface in the form of chips or scratches can be repaired using touch-up paint, which is available in spray cans.

1.16 Cleaning the glass

Incorrect firing, for example using wet wood, can result in the viewing window becoming covered in soot. This soot can be easily and effectively removed by using proprietary stove glass cleaner.

1.17 Scan-Line 500. Cleaning after sweeping or before replacing vermiculite stones

Note: it may be necessary to clean/vaccum the holes and air ducts behind the rear stone.

Order of removing Fire bricks.

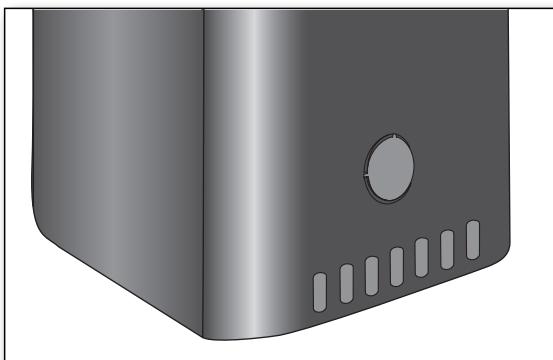
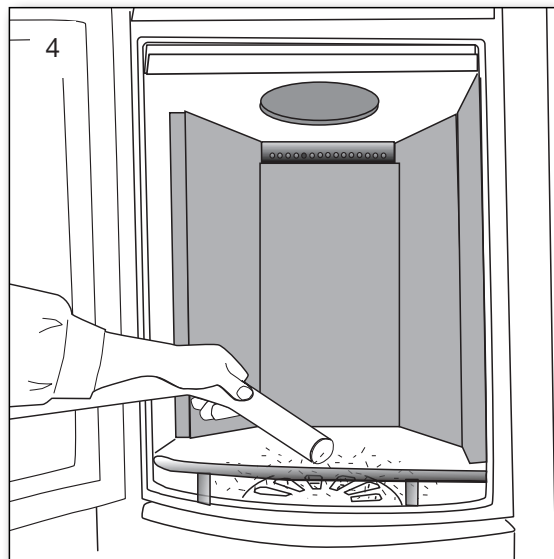
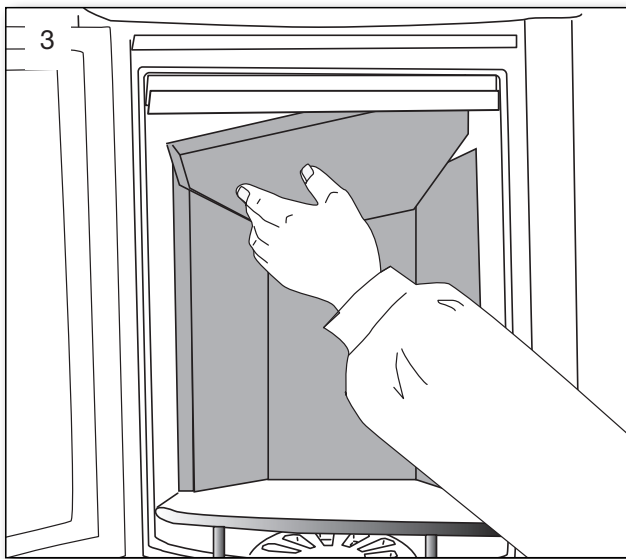
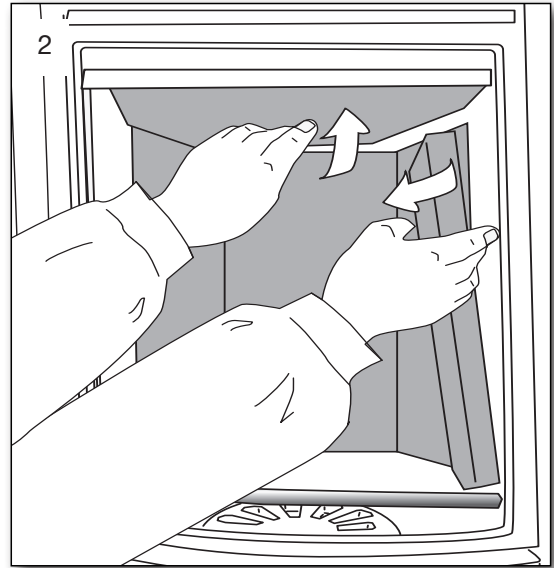
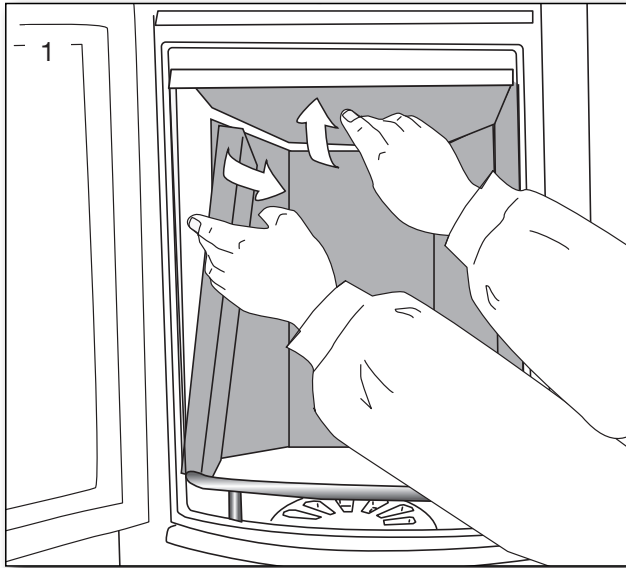

Ovenen er forberedt for friskluft indtag.

1.18 Stove data table in accordance with en 13240 testing

Tested as a freestanding oven and with uninsulated flue

| Stove type Scan-Line | Nominal flue-gas temperature, at 20°C room temperature C° | Flue mm | Fuel volume kg | Draft min. mbar | Nominal output tested kW | Actual efficiency % | Distance to flammable materials | | | Stove weight kg |
|-------------------------|--|------------|-------------------|--------------------|-----------------------------|------------------------|---------------------------------|----------------------|---------------------|--------------------|
| | | | | | | | at the sides mm | rear the stove mm | to furnitures mm | |
| 500 series | 246 | ø150 | 1,2 | 0,11 | 6,1 | 83 | 350 | 150 | 1000 | 114-250 |

The nominal output is the output to which the stove has been tested.

Testing is conducted with the combustion air around 38% open.

1.19 Guarantee

Heta wood stoves, subjected to a strict quality control during production and before delivery to the dealer.

Should you have cause to make a complaint, please quote our invoice no.

Therefore, the stoves guarantee is
FOR FIVE YEARS
 Against defects in manufacturing

Warning



Any unauthorized alterations to the stove and the use of non-original parts will void the warranty.

The guarantee does not cover:

Wearing parts / fragile parts such as:

- Vermiculite stones in the combustion chamber, glass, seals and the casted bottom or shaking grate.
- Damage caused by improper use.
- Transportation costs for warranty repair.
- Assembly / disassembly of warranty repair.

1.20 Parts - Scan-Line 500 - Inside fire chamber

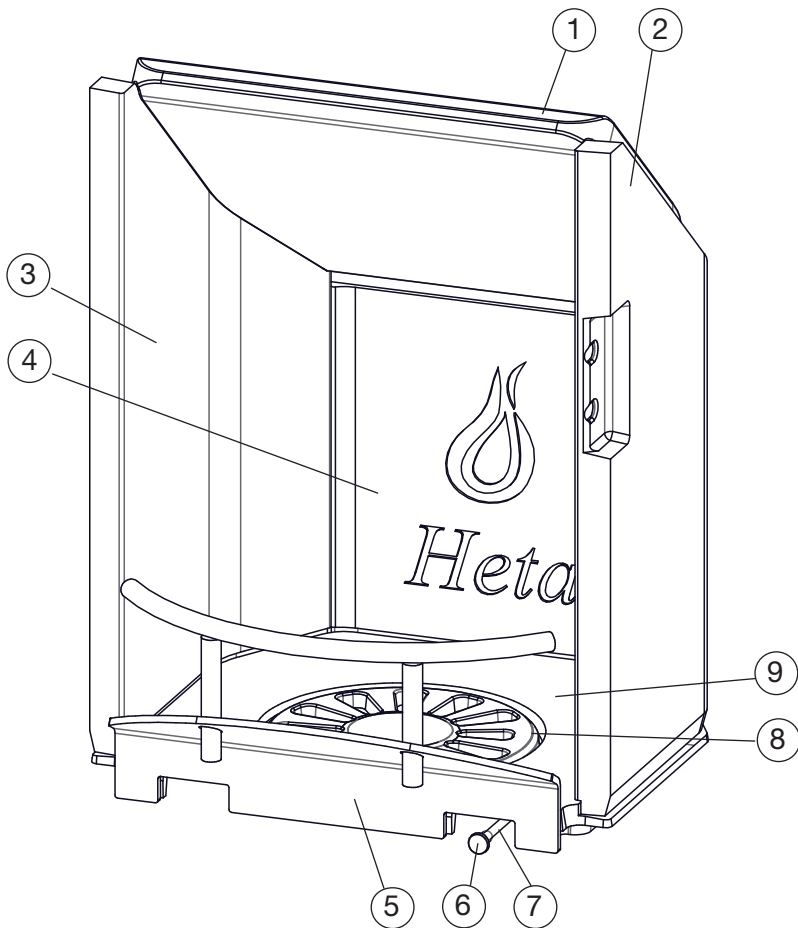

| Pos. No. | Name | Qty |
|----------|----------------------------|-----|
| 1 | 0023-0075 Upper baffle | 1 |
| 2 | 0023-0076 Right side stone | 1 |
| 3 | 0023-0077 Left side stone | 1 |
| 4 | 0023-0078 Back stone | 1 |
| 5 | 1519-0014 Log retainer | 1 |
| 6 | 0015-2013 Knob | 1 |
| 7 | 1021-4062 Shake pin | 1 |
| 8 | 0030-0201 Grate | 1 |
| 9 | 0030-0013 Casted bottom | 1 |

Parts - Scan-Line 550 - Inside fire chamber

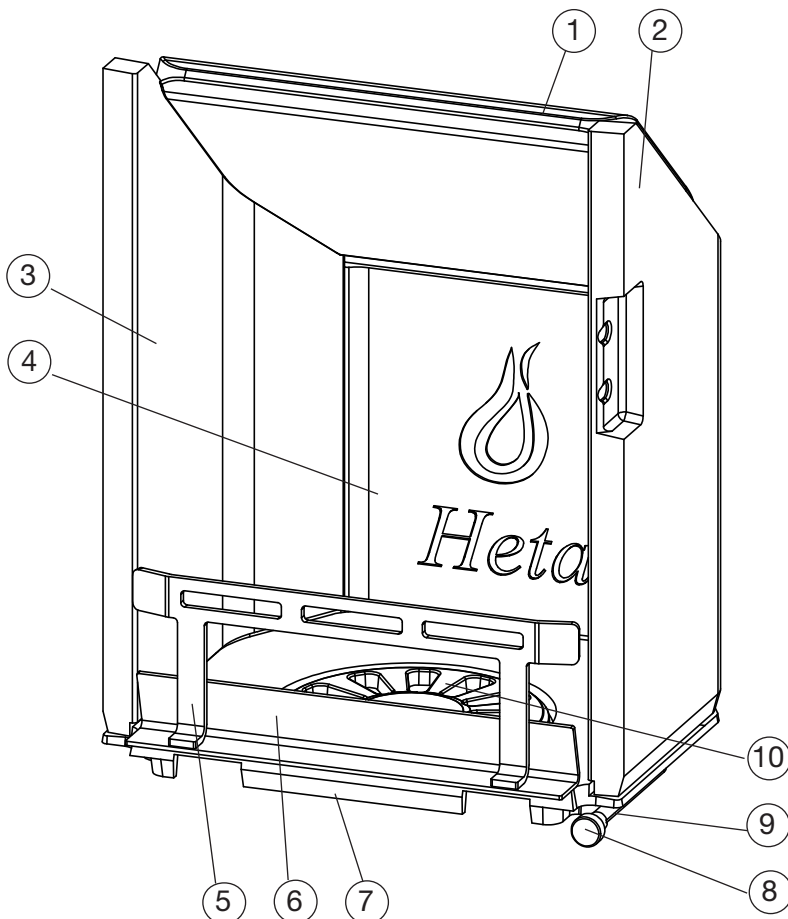

| Pos. No. | Name | Qty |
|----------|----------------------------|-----|
| 1 | 0023-0075 Upper baffle | 1 |
| 2 | 0023-0076 Right side stone | 1 |
| 3 | 0023-0077 Left side stone | 1 |
| 4 | 0023-0078 Back stone | 1 |
| 5 | 1019-0020 Log retainer | 1 |
| 6 | 1019-0019 Inlet | 1 |
| 7 | 0030-0013 Casted bottom | 1 |
| 8 | 0015-1024 Knob | 1 |
| 9 | 1021-0066 Shake pin | 1 |
| 10 | 0030-0201 Grate | 1 |

Installation Instructions

Contents

| | | |
|-----|--------------------------------------|-------|
| 2. | Installation instructions | 16 |
| 2.1 | Distance requirements | 16 |
| 2.2 | Floor | 16 |
| 2.3 | Chimney connection | 16 |
| 2.4 | Combustion air and ventilation | 17 |
| 2.5 | Stovedrawings/measurments | 17-21 |
| 2.6 | Changing to a back flue outlet | 22 |
| 2.7 | Clearances for installation..... | 23 |
| 3. | Appendix A..... | 23 |

Remember

The stove and chimney installation, must comply with local regulations, including those referring to national and European standards.

2. Installation instructions

The stove installation must be in accordance with national, European and possibly local regulations. You must follow local regulations with regard to installation of chimney and connection to the chimney. We recommend that you let a professional Heta dealer install the stove. Alternatively, you can ask the local chimney sweep before installation. Be aware that it is always the owner himself who has responsibility for ensuring that applicable rules are complied with.

A modern stove places heavy demands on the chimney due to the high efficiency. It may be necessary to enhance or even replace an old chimney.

Remember

1. Always ensure free access to any cleaning doors in a chimney.
2. Always ensure ample fresh air to the room.
3. Exhaust/extraction fans in the house can reduce or create negative draft in the chimney. Reduced draft can lead to the stove having adverse combustion properties. It may result in smoke coming out of the stove when the door is open. A negative draft due to an exhaust/extraction fan can cause the chimney to work in reverse, drawing smoke into the house because of the fan.
4. Any air vents must not be covered.

2.1 Distance Provisions

There is a difference between installation next to flammable wall or non-flammable wall. If the wall is made of non-flammable material, the stove in principle may be placed flush against it.

We recommend a minimum of 5 cm to facilitate air circulation around the stove.

The minimum distance to combustibles can be found on the model plate provided with the stove or on page 13 of this manual.

2.2 Floor

You must ensure that the floor can support the weight of the stove and a top-mounted steel chimney.

In front of the fireplace insert, the substrate must consist of non-combustible material, for ex. Steel/glass plate, stone or tile floor. The size

of the non-combustible surface must follow the applicable national and local regulations. Protecting your floor from embers that may fall out of the oven.

Distances see data table page 13.

Pay special attention to the distance from flammable floor, which is also valid even if there are a steel, glass, stone or tile over flammable materials. It is the floor itself, which must be non-flammable. (Concrete, tile or similar). These stoves can be installed on a 12 mm non-combustible hearth.

2.3 The chimney connection

The chimney opening must follow national and local regulations. However, the area of the opening should never be less than 115 cm², which corresponds to a diameter of 121 mm. If a damper is fitted in the flue gas pipe, there must always be at least 20 cm² of free passage, even when the damper is in its “closed” position.

If local regulations permit, two contained stoves can be connected to the same chimney. However, you must abide by local regulations regarding the distance between the two connections.

The stove must never be connected to a chimney that is linked to a gas fire stove.

An efficient stove makes high demand on chimney properties – so always have your local chimney sweep evaluate your chimney.



Connection to a brick chimney

Brick a thimble into the chimney and seat the flue gas pipe in this.

The thimble and flue gas pipe must not penetrate the chimney opening itself, but must be flush with the inside of the chimney duct. Joins between brickwork, the thimble and flue gas pipe must be sealed with fireproof material and / or beading. Heta A/S stresses that it is of utmost importance that this is done correctly with very

tight joints. As mentioned earlier, we recommend that setup and installation be left to a professional Heta dealer.

Connection to a steel chimney

When fitting a connection from a top outlet stove directly to a steel chimney, we recommend fitting the chimney tube inside the flue gas spigot so that any soot and condensation drops into the stove itself rather than collecting on the exterior surface of the stove.

For connections to chimneys that are run through ceilings, all national and local regulations regarding distance to flammable material must be followed. It is important that the chimney is fitted with roof support so that the top panel of the stove is not required to bear the entire weight of the chimney (excessive weight may damage the stove).

2.4

Combustion air and Ventilation

The insert stove is approved as a room air dependent insert stove in accordance with EN 13240. All the combustion air in the inset stove comes from the room in which it is fitted. However, by connecting a sealed air inlet to the insert stove's air intake connector, the stove can be supplied

with external combustion air. In this respect, the following requirements must be met:

- Only approved materials may be used from the ventilation unit to the air inlet vent.
- The air inlet vent must be fitted correctly and insulated to prevent formation of condensate. The cross section of the vent and grille must be at least 78 cm².
- If the vent leads out into the open air, please note that the grille must be fitted with suitable wind protection. There must be no risk that the grille can get clogged by leaves, etc.

Ventilation

Adequate ventilation must be provided in accordance with building regulations (Doc J Oct 2010) especially when installing in newer build properties when the stove is not going to be installed to an outside air supply.

The Scan-Line 500 series has a nominal output of less than 5 kW and does not need additional ventilation in older properties where it will be ventilated by natural leakage.

Houses built after 2008 where the air leakage rate is less than 5 m³/hour / m² then a ventilator equivalent to 550 mm² per kW output will be required (4.5 kW x 550 mm² = 2475 mm²) unless the stove is connected to an outside fresh air supply.

2.5 Stove drawings/measurments

Scan-Line 500

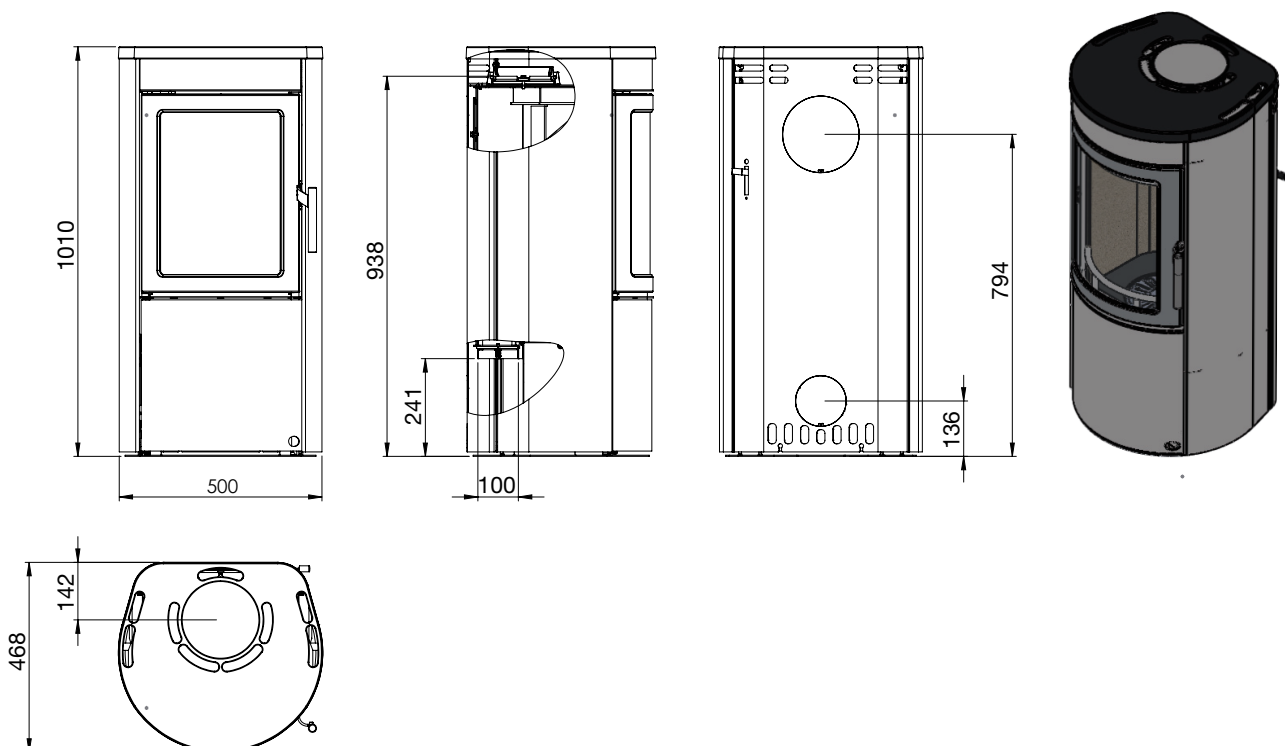

Scan-Line 510

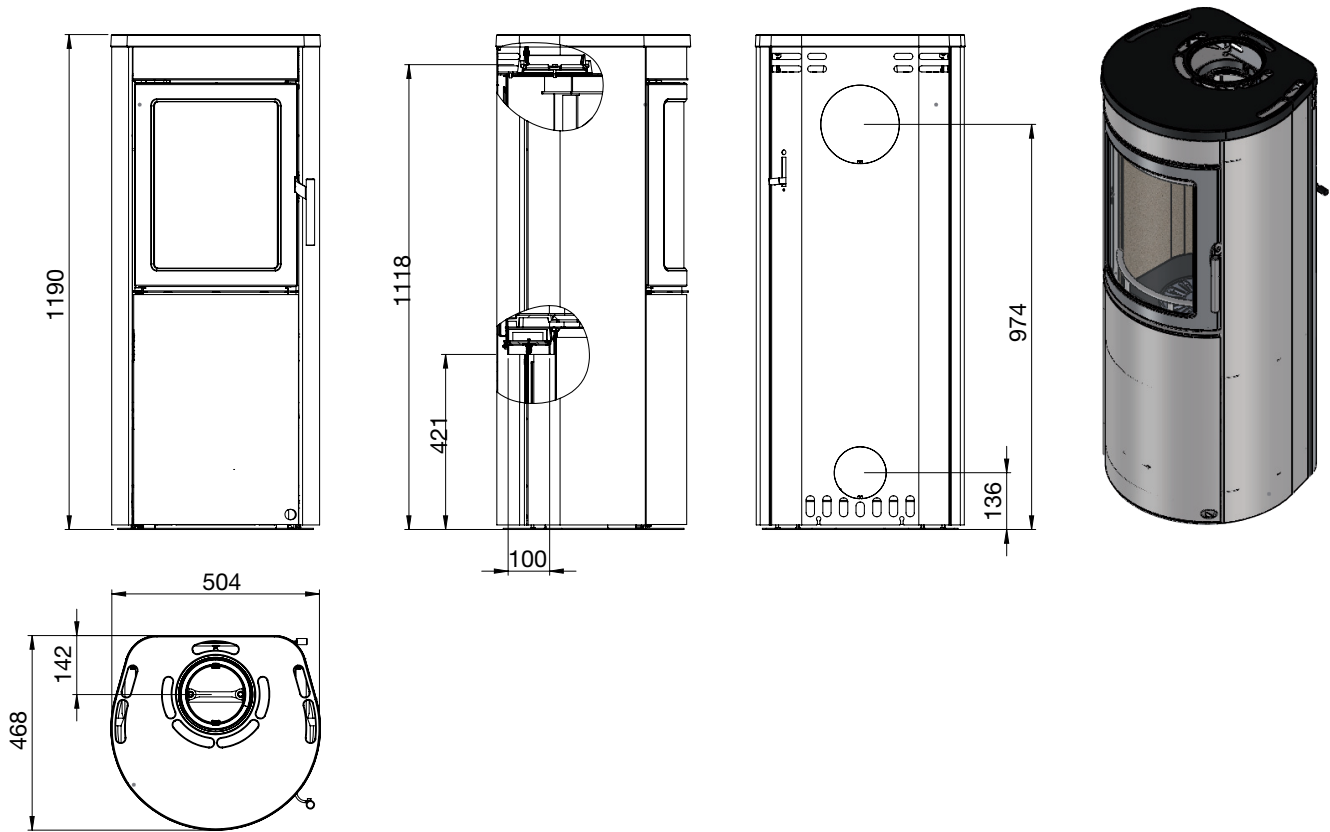

Scan-Line 520

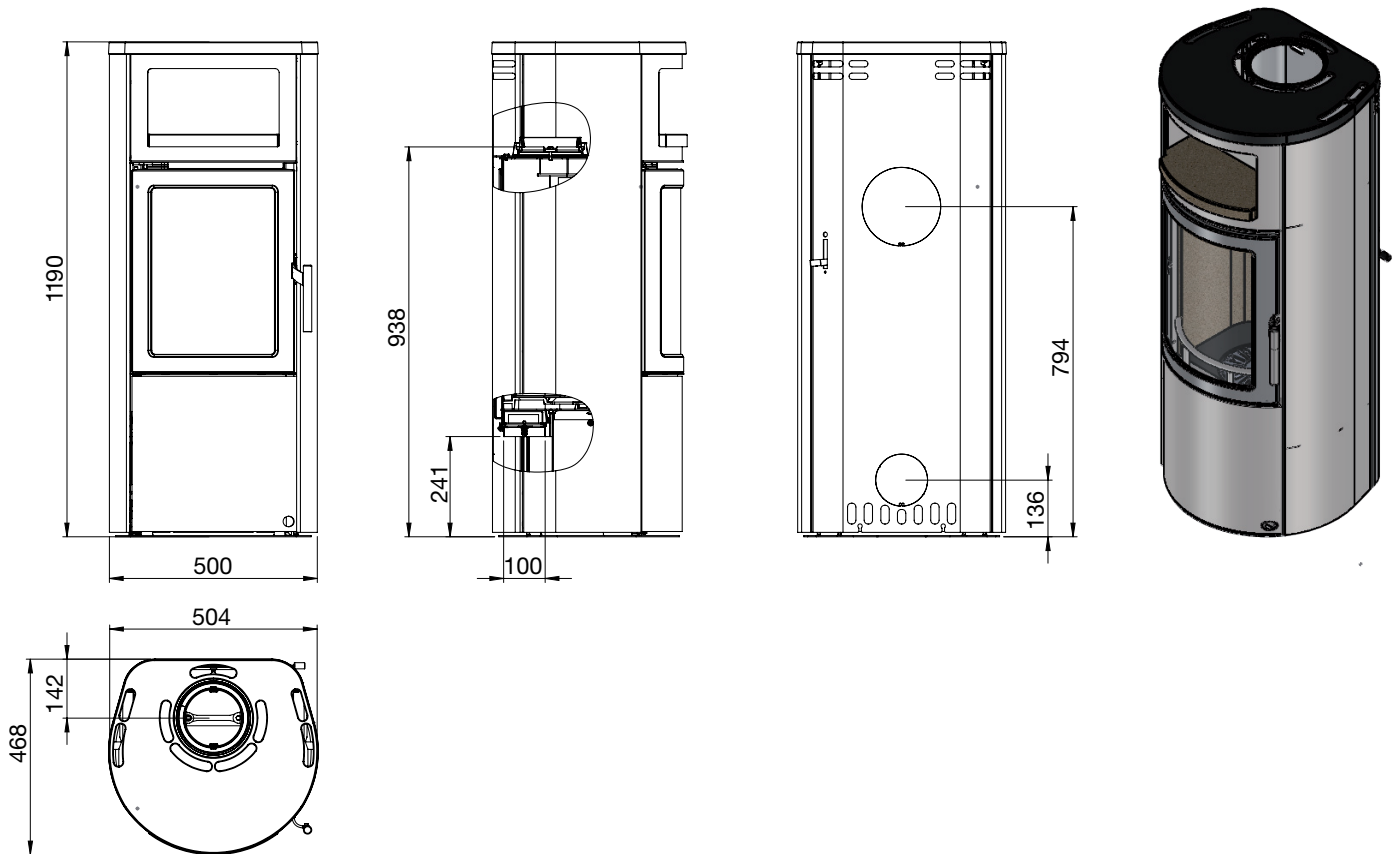

Scan-Line 520B

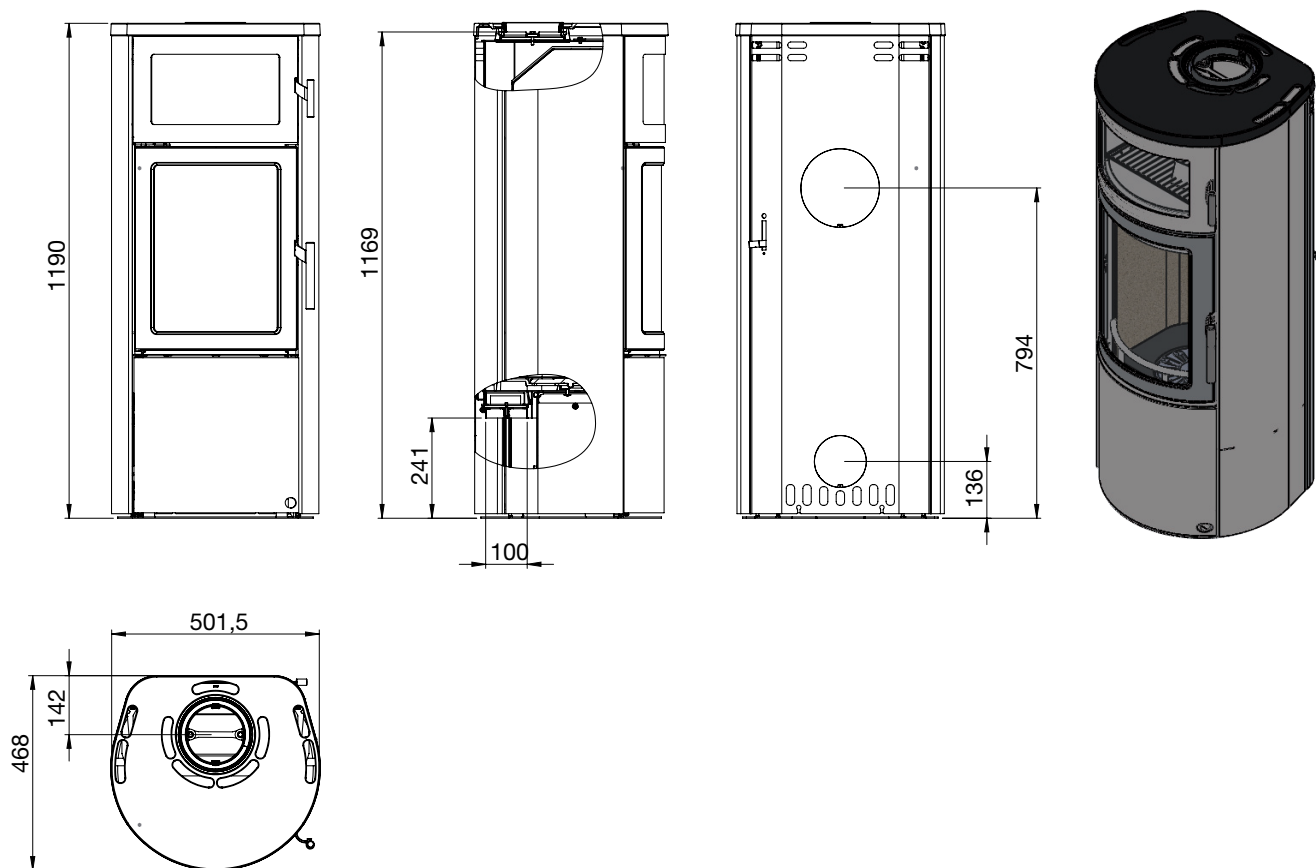

Scan-Line 550

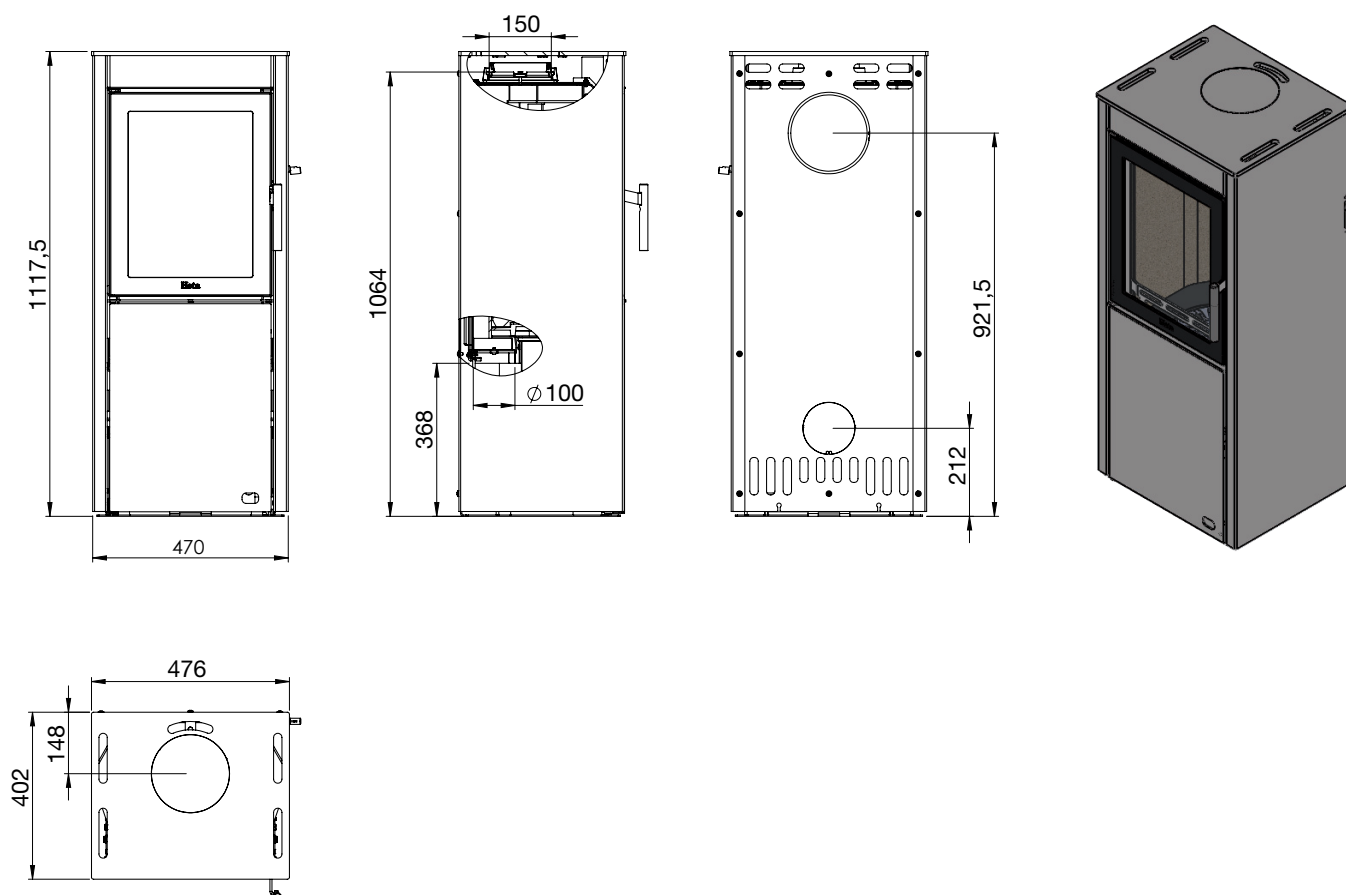

Scan-Line 551

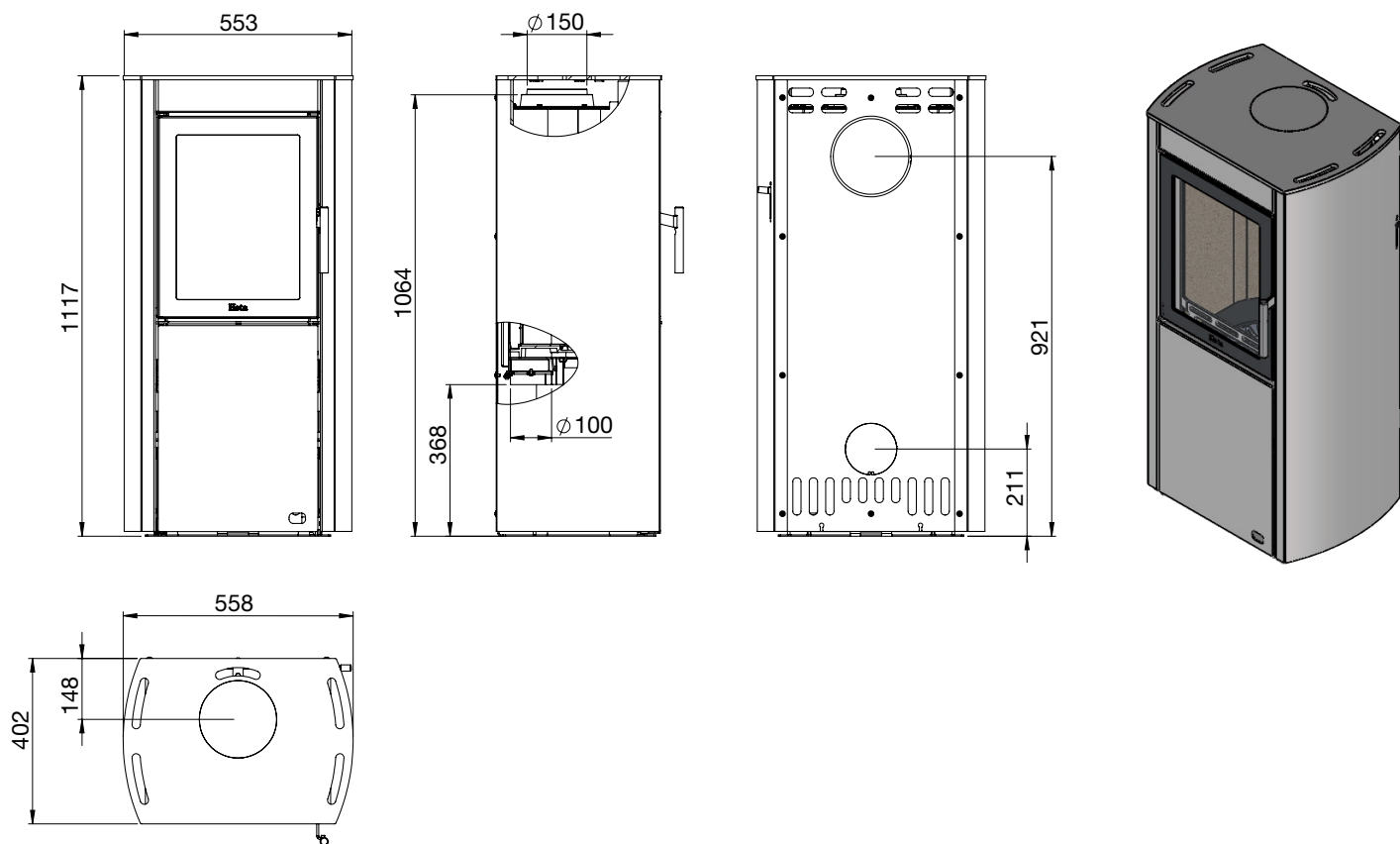

Scan-Line 560S

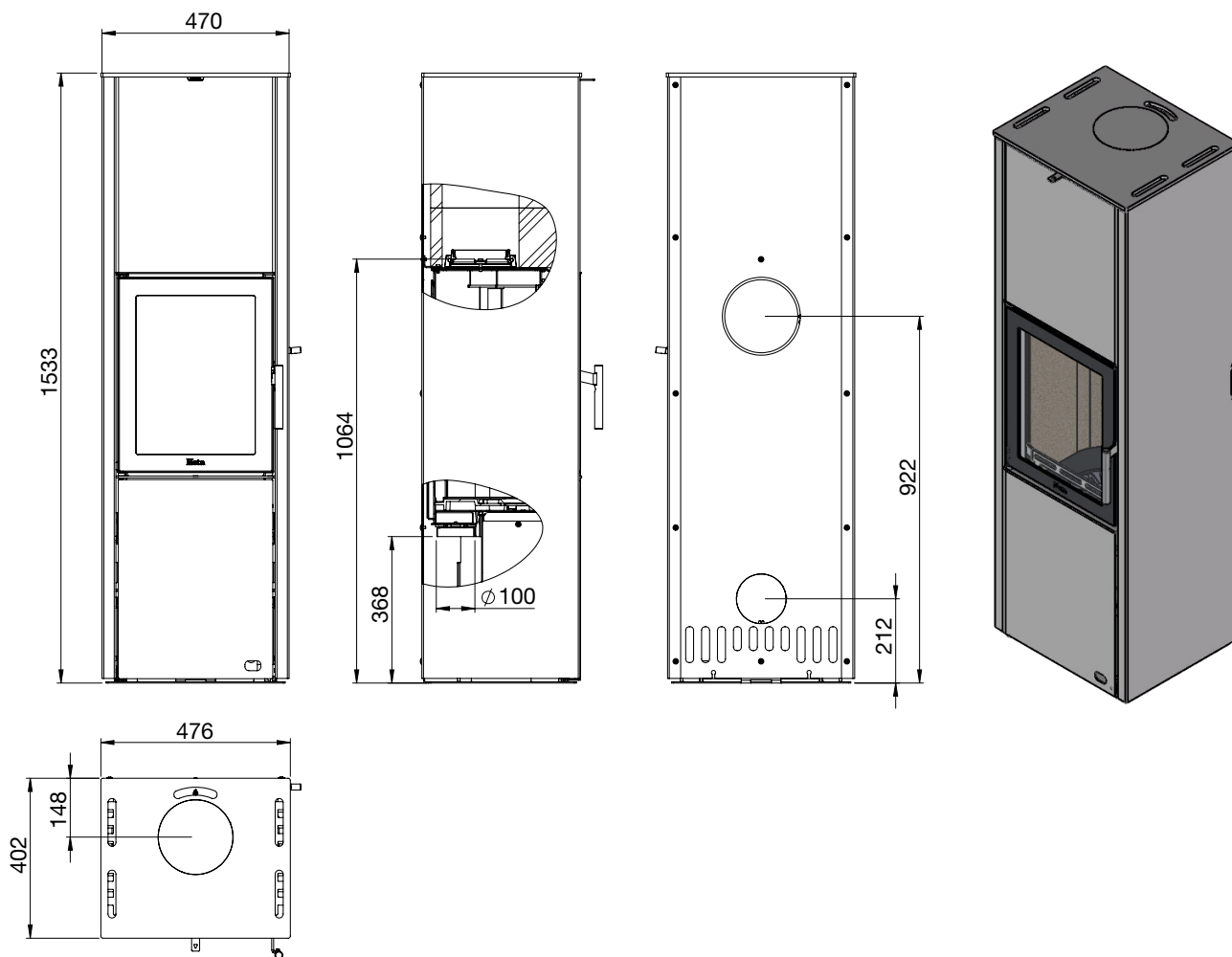

Scan-Line 560B

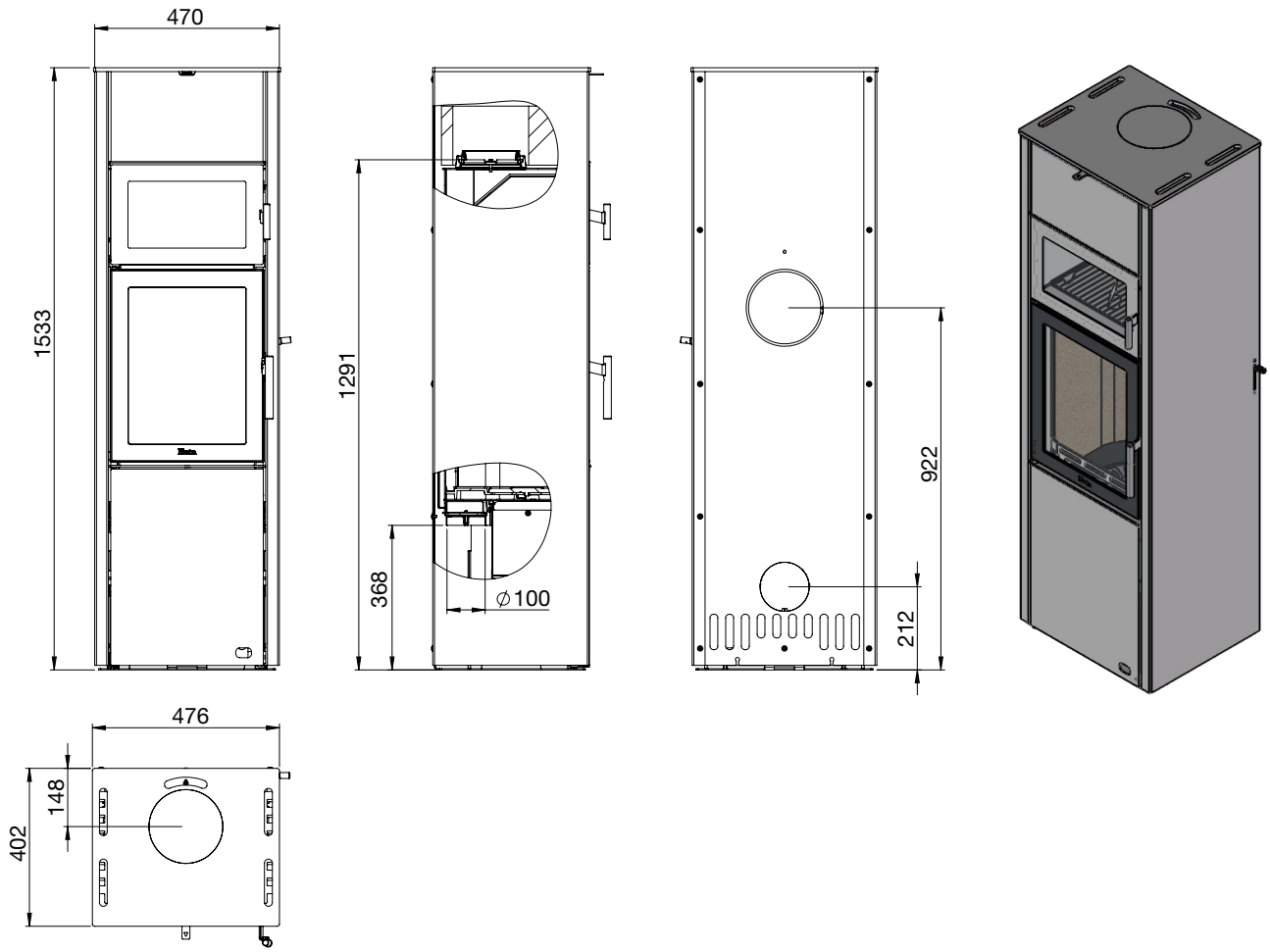

Scan-Line 590

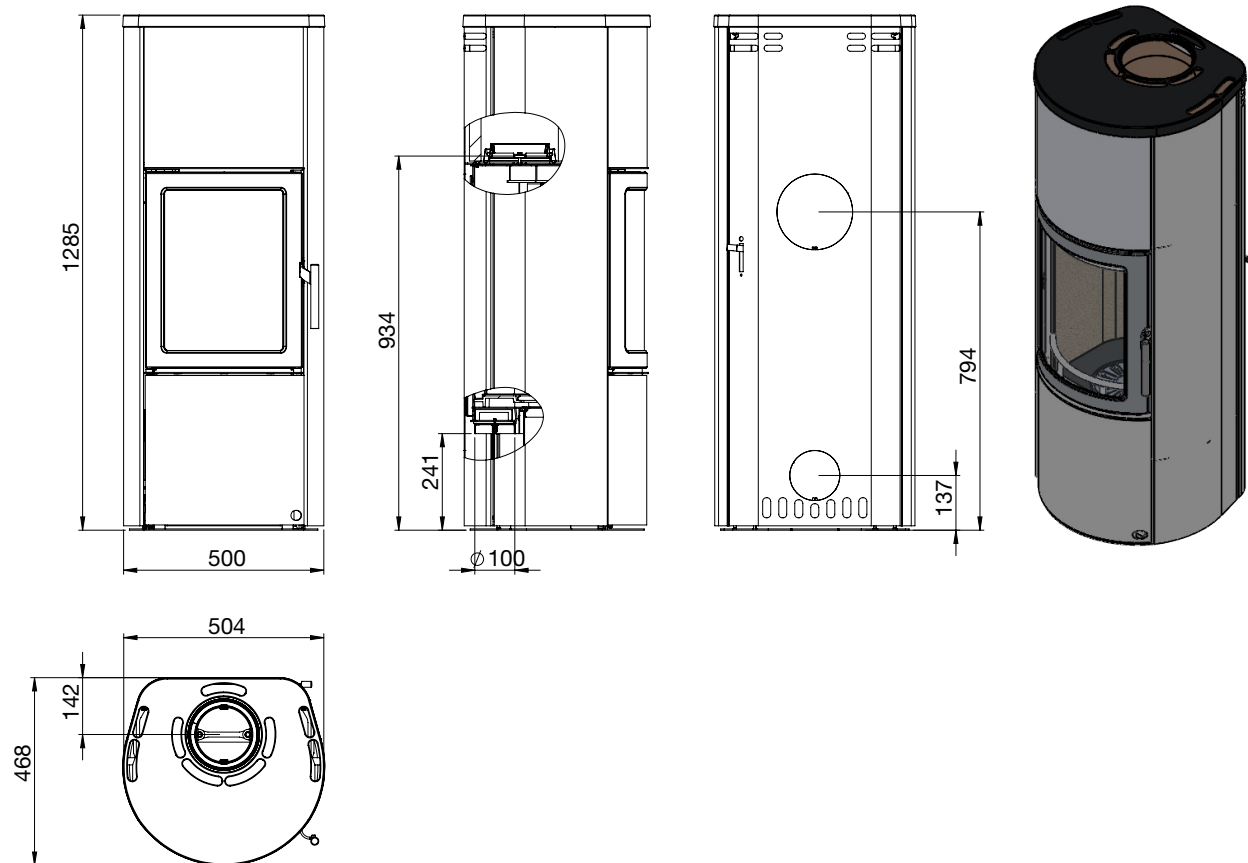

2.6 Changing to a back outlet

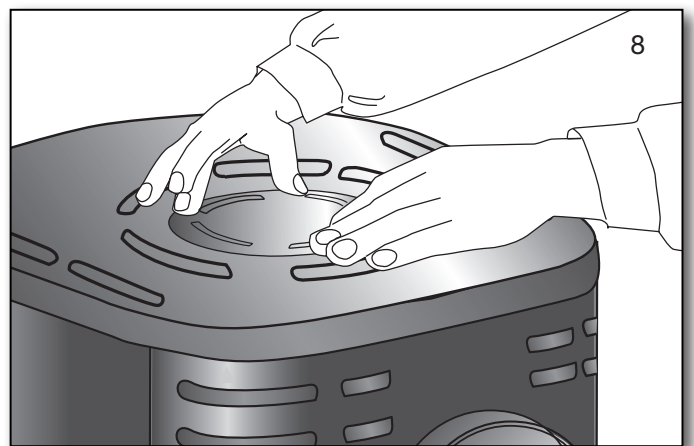
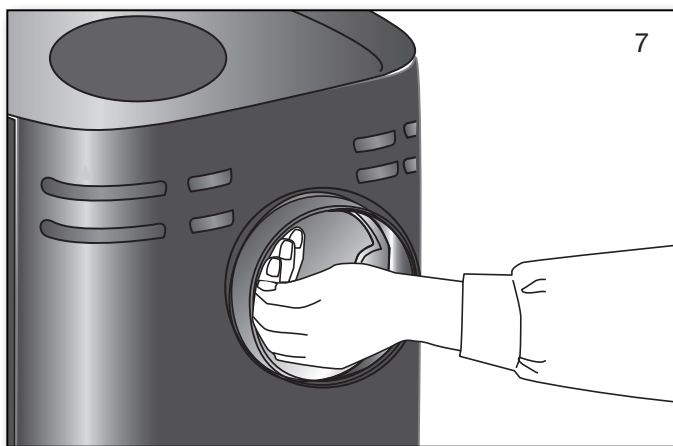
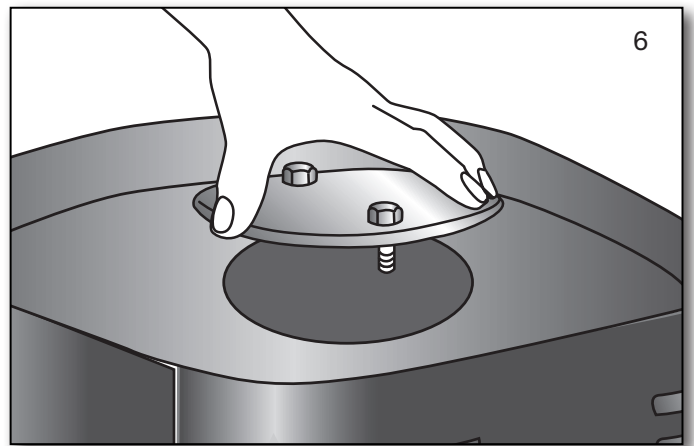
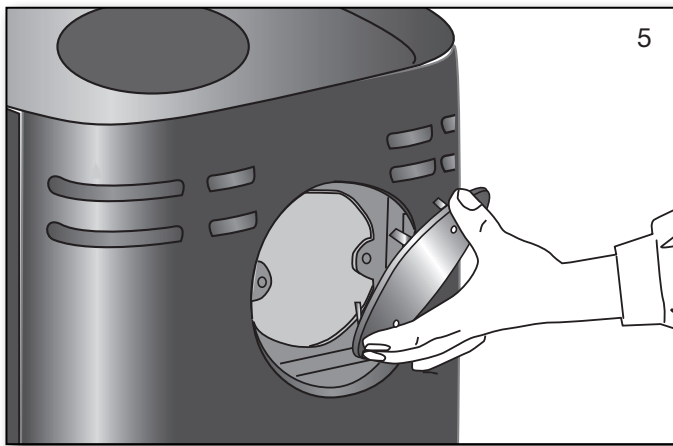
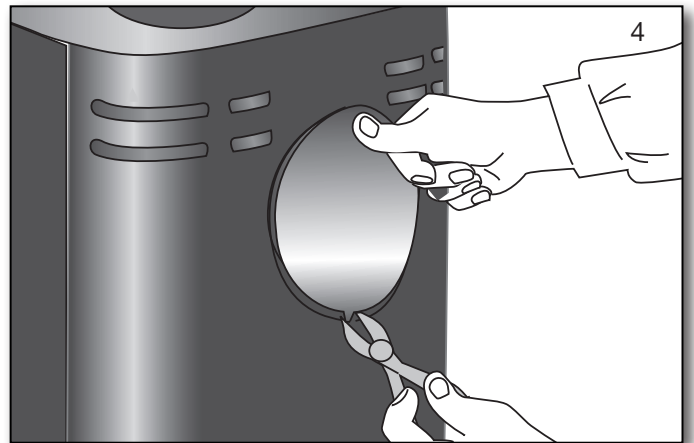
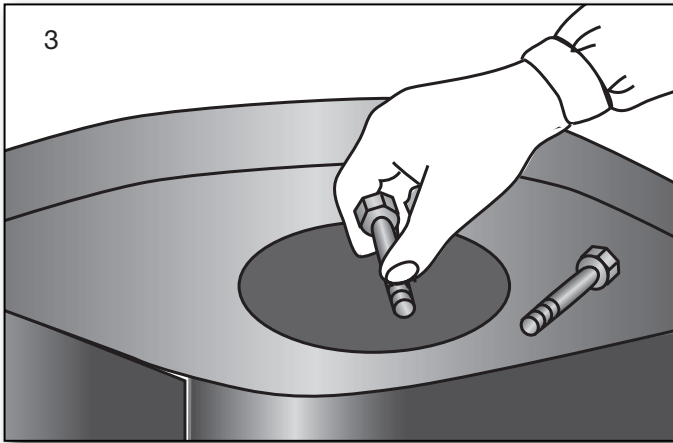
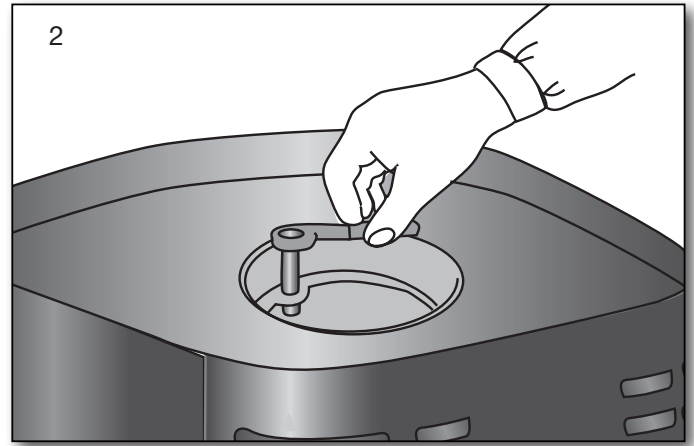
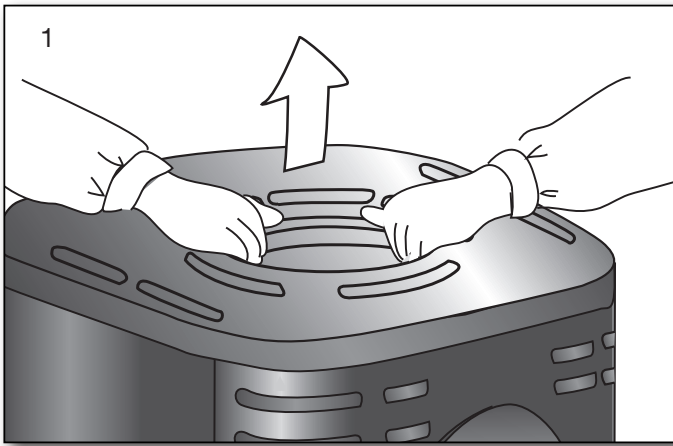

2.7 Clearances for installation EN 13 240

Clearances for installation

| Stove Minimum dimensions | Distance to flammable materials | | |
|--------------------------------|------------------------------------|-----------------------------|------------------------------|
| | A rear the stove | B at the sides | C at furnitures |
| Scan-Line 500 | 150 | 350 | 1000 |
| 510 | 150 | 350 | 1000 |
| 520 + 520B | 150 | 350 | 1000 |
| 550 | 150 | 350 | 1000 |
| 551 | 150 | 350 | 1000 |
| 560S + 560B | 150 | 350 | 1000 |
| 590 | 150 | 350 | 1000 |



The dimensions are the minimum dimensions, unless other-wise stated.

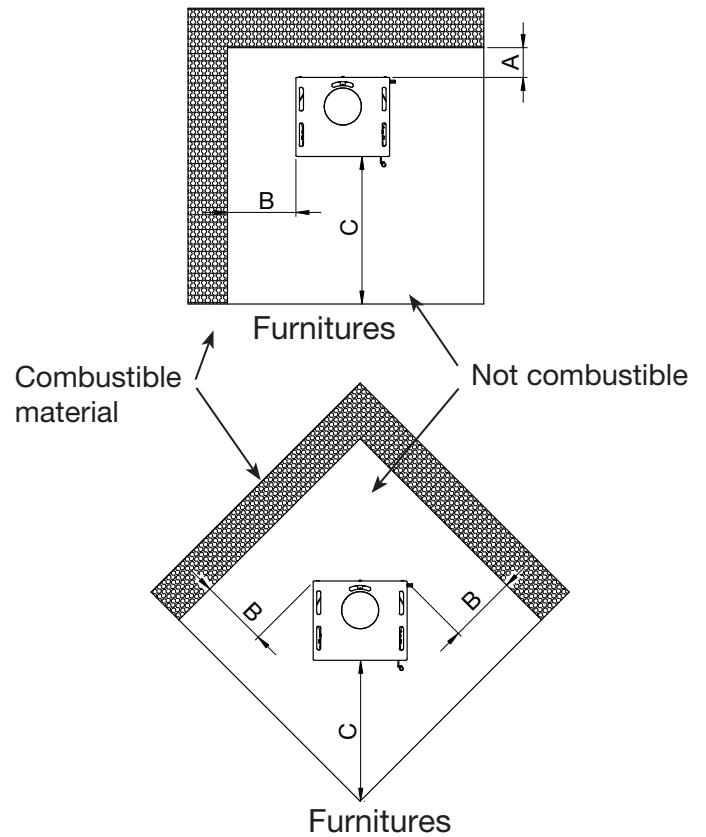

3. Appendix A

The Clean Air Act 1993 and Smoke Control Areas.

Under the Clean Air Act local authorities may declare the whole or part of the district of the authority to be a smoke control area. It is an offence to emit smoke from a chimney of a building, from a furnace or from any fixed boiler if located in a designated smoke control area. It is also an offence to acquire an "unauthorized fuel" for use within a smoke control area unless it is used in an "exempt" appliance ("exempted" from the controls which generally apply in the smoke control area).

In England appliances are exempted by publication on a list by the Secretary of State in accordance with changes made to sections 20 and 21 of the Clean Air Act 1993 by section 15 of the Deregulation Act 2015. Similarly, in Scotland appliances are exempted by publication on a list by Scottish Ministers under section 50 of the Re-

gulatory Reform (Scotland) Act 2014. In Wales and Northern Ireland these are authorized by regulations made by Welsh Ministers and by the Department of the Environment respectively.

Further information on the requirements of the Clean Air Act can be found here:

<https://www.gov.uk/smoke-control-area-rules>

Your local authority is responsible for implementing the Clean Air Act 1993 including designation and supervision of smoke control areas and you can contact them for details of Clean Air Act requirements

The Scan-Line 500 series with and without side windows have all been recommended as suitable for use in smoke control areas when burning dry wood logs.

